

GE Oil & Gas

# Becker\* Control Valve Products

Outstanding Reliability, Accuracy and Control



imagination at work



Since 1955, Becker\* control valve assemblies have been delivering exceptional performance to the natural gas industry. Complete regulator systems from GE Oil & Gas, including Becker control valves, valve regulators, actuators and pneumatic controls, have earned a reputation for outstanding reliability, accuracy and control. Highlighting their advanced engineering technology, these systems continue to provide proven service to customers around the globe.

# Outstanding Products, Advanced Technology

All components of a regulator system must work together to maintain a desired set point of processes that vary in the system -- including pressure and flow rate. Becker control valve assembly components work in synergy to produce a number of competitive advantages.

- **Valve Regulator.** GE Oil & Gas' unique Becker ZERO BLEED\* Valve Regulator Pilot (VRP) instrumentation acts as the brains of the system, effectively combining the capabilities typically found in two devices -- a controller and a positioner. It senses information about each process variable, processes its relationship to the desired set point, and communicates this information to the actuator.
- **Actuator/Pneumatic Controls.** Based on the information received from the valve regulator, the actuator supplies the force and motion to open or close the control valve, which then adjusts for deviations in the set point. Our pneumatic control systems provide unsurpassed control capability with easy adjustment and negligible to non-existent atmospheric bleed. Becker actuators can be supplied with custom-designed control systems to meet highly specific customer requirements. Whether installed in the field or factory-assembled, they can be tested on the valve of your choice.
- **Control Valve.** The control valve affects the flow of fluid to control pressure differential, flow rates, velocity and noise. A variety of different Becker T-Ball\* rotary-style control valves are available to best fit your needs.

## In-depth Knowledge & Experience

GE Oil & Gas' engineering staff offers a wealth of knowledge and decades of experience related to control valve technology and applications. Let us help you create a regulator system that is best suited to your precise application. Becker control valve assembly products and accessories provide exceptional quality and performance backed by the significant engineering experience and ongoing support of GE Oil & Gas.

## T-Ball Control Valve Advantages

Becker T-Ball rotary-style control valves from GE Oil & Gas are ideally suited for natural gas applications. They offer significant competitive advantages compared to cage-style valves (axial and globe):

- **Self-cleaning Design.** The rotating ball allows for debris in the pipeline to be swept downstream rather than building up in the valve, reducing maintenance time and costs, and maximizing uptime.
- **Standard Bi-Directional Flow.** The ball design of the valve allows for media to travel in both directions of the pipeline, resulting in significantly reduced infrastructure requirements and costs.
- **High Capacity & Turndown.** Our control valves can handle high flow volumes while effectively maintaining accurate control in both high and low flow rates. The T-Ball design can handle flow volume equivalent to approximately two axial-style valves or three globe-style valves, offering a substantially reduced station/infrastructure footprint.
- **Below Ground Installation.** Unlike cage-style valves, T-Ball control valves can be buried below ground, providing several key benefits:
  - Reduced noise levels by up to an additional 35 dBa (offers a more cost-effective solution than silencers and capacity reducing trim designs)

# Becker Rotary Control Valves

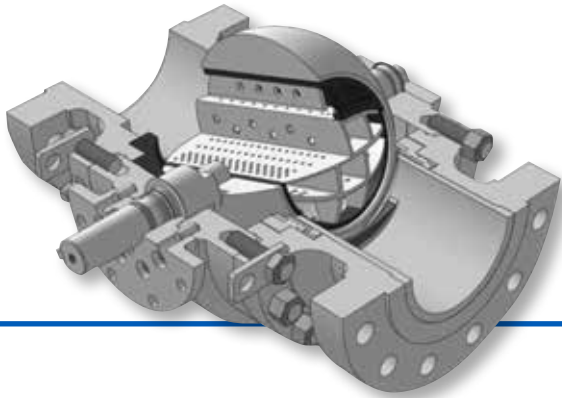

## T-Ball Control Valve

Now, more than ever, the energy industry is pushing the limits to maximize process yields while maintaining a safe, efficient and sustainable operation. The T-Ball control valve, combined with advantages of Becker pneumatic or electronic actuation and instrumentation provides an engineered solution for an array of gas or liquid applications that may require aggressive noise attention, high pressure differential, large mass flows with extreme precisions and reduced emissions.

The patented T-Ball rotary control ball valve offers a unique design with its inlet and outlet diffusers that engage the valve. Combined with its quarter-turn operation it has the inherent capability to control over a wide range of process conditions while maintaining low-impact, quick and smooth modulation.

Time and time again, the T-Ball has proved to provide customers worldwide with process management solution for pipeline applications ranging from oil and gas production, processing, transitions, storage and distribution.

## Trim Selection

Through a series of trims for gas or liquid, the T-Ball is customized to suit specific application needs. An FPCV-T0 is ideal for applications that require high mass flow rates with minimum pressure differentials while an application that requires high pressure differential and aggressive noise attention a QTCV-T4 model can be used.



Becker T-Ball Model	FPCV-T0	QTCV-T1	QTCV-T2	QTCV-T4
Noise Attenuation	Baseline	7 dBa	17 dBa	25 dBa

# Becker Series V-O Control Valve



## Series V-O Control Valve

The Becker V-0 Control valve is a segmented type rotary control valve designed for mild duty regulation. The V-0 features a high capacity design in a very compact package by utilizing Becker RSD Rotary Spring and Diaphragm actuators paired with environmentally friendly ZERO BLEED digital or pneumatic instrumentation. The V-0 control valve is ideal for gas production, midstream, distribution and transmission applications and can be used for:

- Flow Control
- Pressure Control
- Over Pressure Protection
- Under Pressure Protection

# Becker Rotary Series High Pressure Actuators

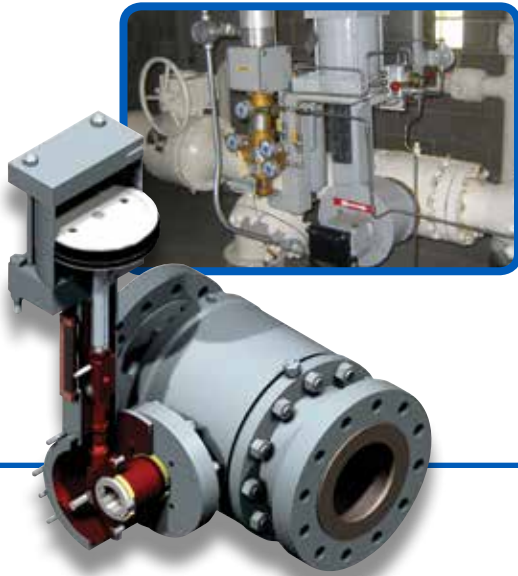

## RPDA Rotary Piston Double Acting Actuator

- Bleed to Pressure System™ can eliminate bleed gas emissions
- Retrofits to almost any pipeline valve
- High pressure RPDA accepts natural gas up to 500 psig (3,447 kPa)
- Upright actuator design saves space and promotes longer actuator piston seal life
- Designed to be maintenance free
- All RPDA's come equipped with a precision linear scale that indicates valve position in ten degree increments
- Crank-arm design actuators specifically suited for control valve applications
- May be mounted in any orientation

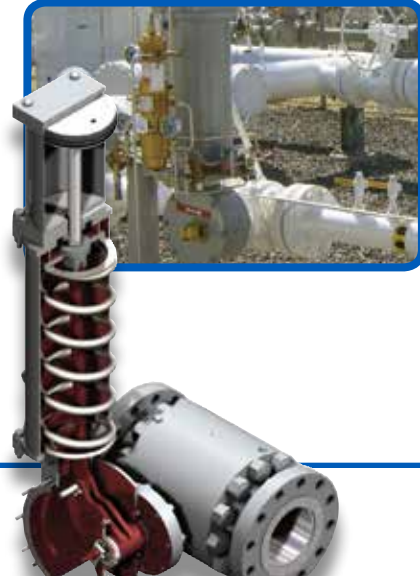

## RPSR Rotary Piston Spring Return Actuator

- Bleed to Pressure System™ can eliminate bleed gas emissions
- Retrofits to almost any pipeline valve
- High pressure RPSR accepts natural gas up to 500 psig (3,447 kPa)
- Upright actuator design saves space and promotes longer actuator piston seal life
- Designed to be maintenance free
- All RPSRs come equipped with a high visibility scale that indicates valve position
- Crank-arm design actuators specifically suited for control valve applications
- May be mounted in any orientation

# Becker Linear Series Low and High Pressure Actuators with Globe Valves

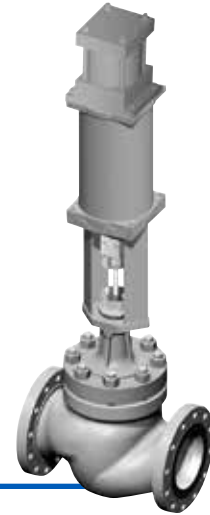
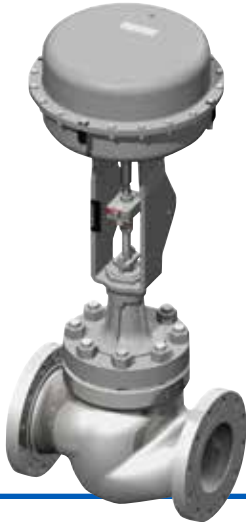

## LD Linear Diaphragm

- Utilized when available power gas pressure is less than 50 psig (344 kPa)
- High power output with low power gas supply
- Simple instrumentation design
- ZERO steady state bleed gas when utilizing Model HPP-SB Positioner or Model VRP-SB Pilot

## LPDA Linear Piston Double Acting

- Bleed to Pressure System\* can eliminate bleed gas emissions
- Retrofits to almost any pipeline valve
- Available with a weather seal design to protect piston rod
- High Pressure LPDA Actuator accepts natural gas up to 500 psig (3447 kPa)
- Upright actuator design saves space and promotes longer actuator piston seal life
- Maintenance free design
- All LPDAs come equipped with a precision linear scale that indicates valve position in ten degree increments

## LPSR Linear Piston Spring Return

- Bleed to Pressure System\* eliminates bleed gas emissions
- Retrofits to almost any pipeline valve
- High Pressure LPSR Actuator accepts natural gas up to 400 psig (2758 kPa)
- Maintenance free design
- All LPSRs come equipped with a high visibility scale that indicates valve position
- Specifically suited for heavy duty control valve applications.
- "Surge Design" available for high speed stroking up to 750 mSec
- Field reversible

## Becker Globe Valve Characteristics

CV	41005, 21000
1" - 8" lines	1" - 16" lines
High capacity (larger holes)	High noise attenuation (smaller holes)
Small to medium power plants	Higher pressure drop capabilities
Top entry design facilitates maintenance and allows in-line valve service	Reduce actuator size and thrust requirements
Interchangeable internal components	Improved stability with larger guide areas
Throttling while at maximum pressure drops	Increase low noise and anti-cavitation trims

# Becker Valve Regulator Pilot (VRP) and VRP retrofit

The Becker Valve Regulator Pilot (VRP) provides pneumatic pressure control for gas applications. The VRP measures the downstream pressure and utilizes pipeline gas to power the actuator and position the valve to maintain the desired setpoint.

The VRP provides the following benefits:

- Maintains control within 0.75% of desired setpoint
- Combines the functions of a positioner and a controller into a single device
- ZERO steady state emissions
- Unique to Pressure System can completely eliminate instrumentation emissions
- Models suitable for both double acting and single acting actuators
- Ability to retrofit to any style valve already in the field

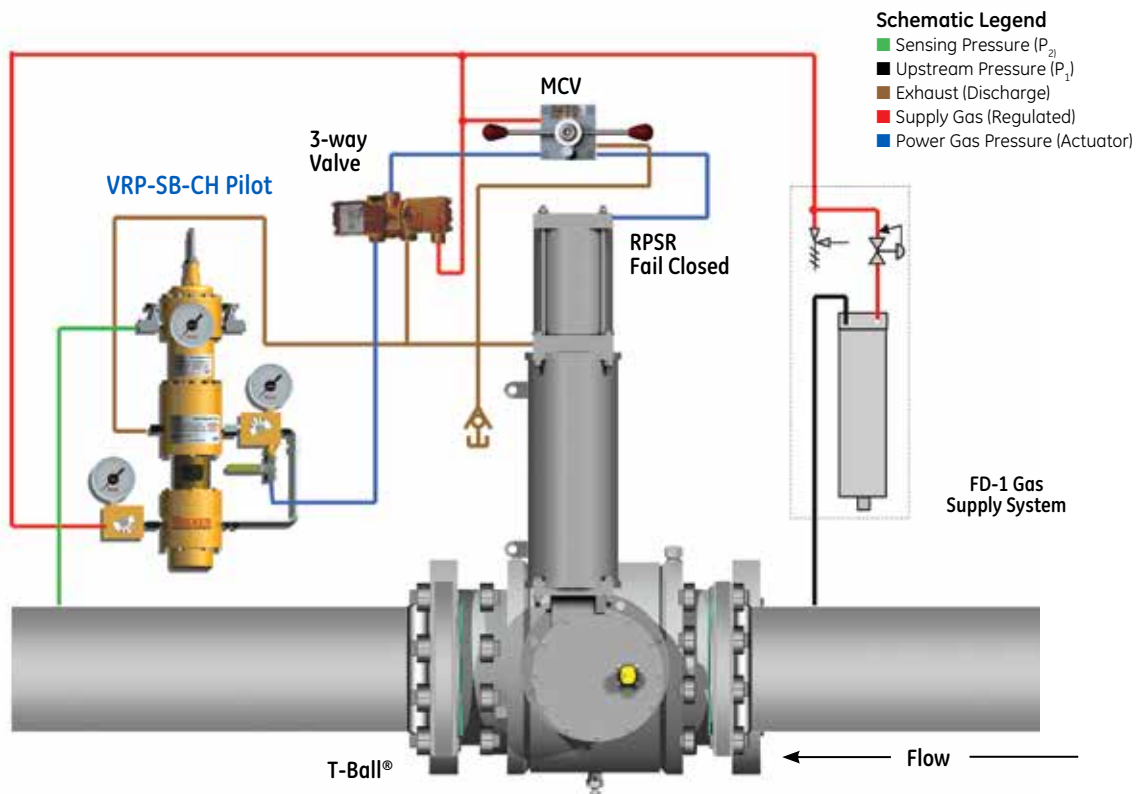
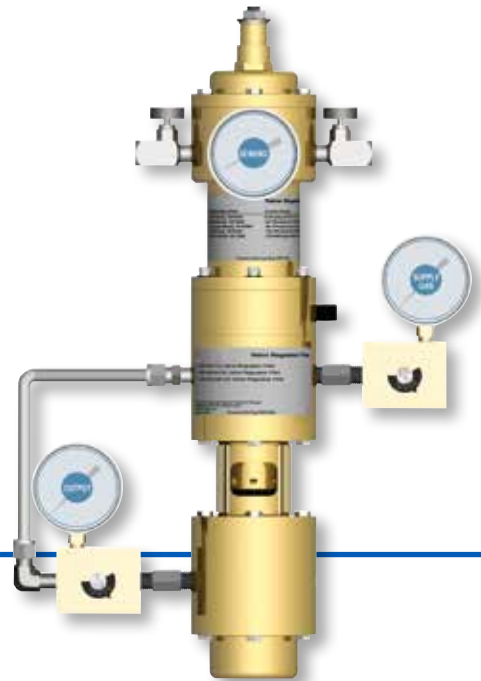

Rather than venting gas to the atmosphere, gas is displaced downstream back into the pipeline, completely eliminating emissions and providing a true ZERO BLEED system.



For control valve instrumentation that is obsolete, providing poor control or exhibiting high emissions-- a Becker VRP can easily replace instrumentation on an existing control valve in service.

Studies have shown that pneumatic control valve instrumentation annually can vent up to 500,000 scf of methane into the environment. Maintaining a sustainable, environmentally friendly operation is becoming an increasingly top priority for many pipeline operator. A single VRP retrofit can potentially reduce or even eliminate those emissions with the Bleed to Pressure System. This reduction is equivalent to approximately 25 metric tons of CO2 which is equivalent to:

- The annual greenhouse gas emissions from 5 passenger vehicles\*\*
- Carbon sequestered annually by 5 acres of pine or fir forest\*\*

\*\*Source: EPA Greenhouse Gas Equivalencies Calculator



# Becker HPP Pneumatic Positioners Provide Accurate Positioning of Control Valves with Reduced Bleed Emissions



HPP-SB models for Single-Acting Applications

The Becker HPP provides accurate positioning for both single-acting and double-acting actuated control valves. It can be configured in both reverse and direct-acting with a variety of instrument signal input ranges. The device accepts a pneumatic instrument signal from an I/P transducer or a pneumatic controller. The HPP provides the following benefits:

- High flow capacity—ideal for fast acting applications
- ZERO steady state bleed and when in full open and closed
- Elimination of instrumentation emissions when combined with Bleed to Pressure System
- Vibration resistant design maintains calibration

# Becker DNGP Digital Natural Gas Positioner

The DNGP can be used with both double acting and single acting actuators.

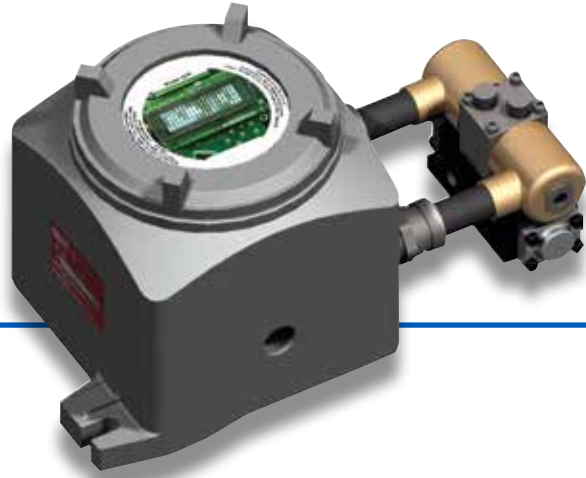

The Digital Natural Gas Positioner (DNGP) is used with pneumatically actuated control valves in gas applications for both flow and pressure control. The device accurately positions the valve stem proportionally to the command of the input signal received from an electronic controller. The DNGP provides the following benefits:

- Eliminates the need for an I/P transducer
- ZERO bleed consumption at steady state
- Easy, menu driven setup along with PC interfaced diagnostic and setup features
- High volume and pressure capabilities ideal for large volume pneumatic actuators
- Multiple fail safe mode options
- Modbus communication protocol

# Commitment to the Environment

Sustainable and environmentally friendly technology is a continuously growing industry trend. The environmental impact of noise and pollution from natural gas regulating stations is becoming an increasingly important design consideration.

Many methods of handling excessive noise, such as downstream silencers, extra-thick pipe, and enclosure buildings, only offer a partial solution and multiply project costs. Buried installation of T-Ball® control valves can easily be configured with a robust extended stem design. This can eliminate ambient noise problems (up to 37 dBA) by the earth's absorption of noise producing vibrations. Due to the T-Ball's inherent non-clogging, low maintenance design, your station is not required to be frequently unearthed and serviced.

Besides optimum noise control and infrastructure reduction, buried service provides considerable benefits:

- Ability to Handle Higher Flow Volumes
- Minimize Ambient Heat Loss
- Additional Asset Security
- Safer Atmosphere for Operating Personnel
- Compliance with Environmental Regulations and City Ordinances

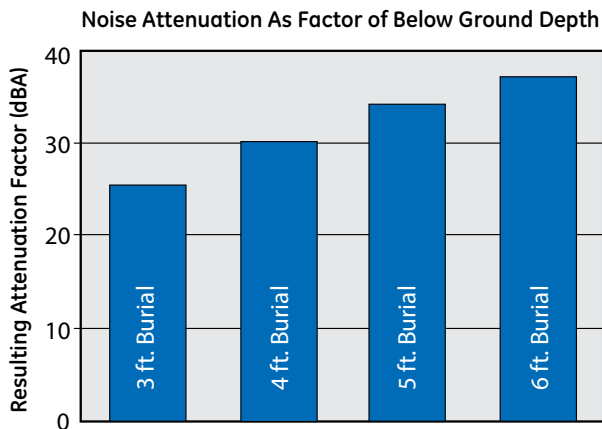

Burial depths typically range from 3 ft (1m) to 6 ft (2m) and can provide in excess of 37 dBA of additional noise attenuation.



# Combustion Turbine Power Plants Regulator/ Trim Run Solution



This application provides the challenge of essentially requiring infinite turndown (to meet the small gas flow rate demands of ancillary equipment), allowing for smooth start-up of the combustion turbine, and providing enough capacity for multiple turbines at 100% loads. Additionally, the control valve system must have exceptional speed of response because of the proximity to the combustion turbines. This speed of response cannot come at the expense of maintaining stable steady-state control. This is especially critical to the commissioning of new CT power plants as fluctuating inlet pressure to the CTs will not allow the units to pass emission requirements and could cause a unit or multiple units to trip off line.

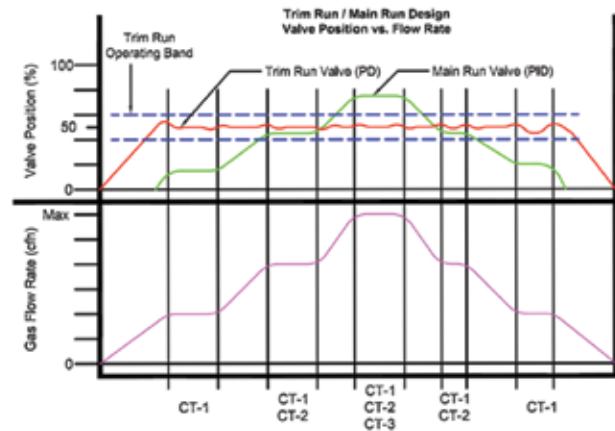

**Figure 4**

The Main Run provides all the gross gas load requirements at set-point pressure, and the quicker Trim Run maintains the fine control no matter how many CTs come on line. The Trim Run will operate between 40-60% open under normal operation with 50% as its target position for the station set-point. This identical process will take place in the opposite direction if there is a large decrease in gas flow rate demand. It is this ability to satisfy both large and small gas load requirements at the same time and maintain control that makes this design the right choice for CT power plants. By having both runs in control and having the Trim Run as the “leading” function, the station will have a fast speed of response coupled with tight control capability and a stable delivery pressure, under all operational conditions.

## Becker Accessories



### MCV

The MCV Series Manual Control Valve provides manual operation of pneumatic valve actuators. The MCV is the ideal device for maintenance and manual operation of control valves. The MCV allows the user to override the primary control instrumentation and position the control valve actuator. The unique safety button feature of the MCV prevents unintentional operation. An optional locking feature is available for additional security.

#### Max. Allowable Operation Pressure

**Model MCV-3:** Up to 150 psig (1034 kPa)

**Model MCV-3M:** 150 - 250 psig (1034 - 1724 kPa)

**Model MCV-3H:** 250 - 500 psig (1723 kPa - 3447 kPa)

**All Ports:** 1/4" FNPT

**Weight:** 10 lbs (4.5 Kg)



### Gear Operator Override

The manual handwheel is utilized for manual operation of small and medium sized control valves when pneumatic power is not available. The handwheel utilizes a system of gear multipliers to develop necessary torque to open and close the control valve.



### No-Bleed Valve NBV Series

The No-Bleed Valve NBV Series eliminates bleed gas from Becker double-acting control instrumentation when corresponding control valve is at full-open and full-closed positions. This is ideal for monitor regulators and standby regulators that typically remain in the full-open or full-closed positions for extended periods of time. The NBV features bleed shutoff at both ends of valve travel without adjustment. The NBV is the primary choice for Non-Bleed technology on Becker double-acting control instrumentation. The NBV is compatible with all Becker double acting Valve Regulator Pilots (VRPs) and double acting High Pressure Positioners (HPPs).



### PS-2 Series Non-Bleed Sensor

The PS-2 Series Non-Bleed Sensor eliminates bleed gas from Becker seat and nozzle type double-acting control instrumentation when corresponding control valve is at full-open or full-closed positions. This is ideal for monitor regulators and standby regulators that typically remain in the full-open or full-closed positions for extended periods of time. The PS-2 features bleed shutoff at one end of valve travel. If bleed shutoff is required at both ends of valve travel, two PS-2 Non-Bleed Sensors are required. The PS-2 is typically utilized for high pressure power supply gas greater than 150 psig (1034 kPa) or when Bleed to Pressure System (BPS™) discharge pressures exceed 60 psig. The PS-2 is compatible with the following Valve Regulator Pilots (VRPs) and High Pressure Positioners: Models VRP, VRP-CH, HPP-4.



### PIC & GSP Series Pressure Instrumentation Columns

The Becker PIC and GSP Series Pressure Instrumentation Columns provide (413 kPa) regulated and conditioned supply pressures for control valves and instrumentation utilized in natural gas pipeline applications. PICs are available with a variety of options and configurations, such as catalytic (flameless) heaters, filter-dryers, instrumentation mounting brackets. The Becker PIC is the original column designed for use in natural gas distribution and transmission pipelines.





**GE Oil & Gas**

1550 Greenleaf Avenue  
Elk Grove Village, IL 60007  
Email: [becker@ge.com](mailto:becker@ge.com)

Visit us online at: [www.ge.com/energy](http://www.ge.com/energy)

2014 General Electric Company  
All Rights Reserved

\*Trademark of General Electric Company